

PS-150E PanelSafe Easy Fit - Self Tapping Male

INDUSTRY FIT: 

SPECIFICATIONS:

PANELSAFE PS RANGE

PanelSafe Easy Fit restraint systems provide added security and control. The panel is suspended below the ceiling for convenient servicing behind the panel or controlled removal of the panel by releasing the wire. For use with Fastmount system clips and installation tools.



PS-150E

USE WITH:
PC Standard Range
LP Low Profile Range
VL Very Low Profile Range
MC Metal Range

MATERIAL:
 Aluminium and stainless steel

MORE INFO:
 Installation Guide FM IG PS-150E
 Clip Layout Guide FM IG PS-150E P62

BENEFITS

- Provides extra security for heavy panels
- Easy one person removal of large panels
- Convenient servicing behind panel without full removal
- Prevents panels falling during fire exit
- Works with existing Fastmount clips
- Variable length to suit application
- Surface mount option available

APPLICATIONS

- Heavy panels
- Large panels
- Inspection and service panels
- Panels above valuable furniture and artwork

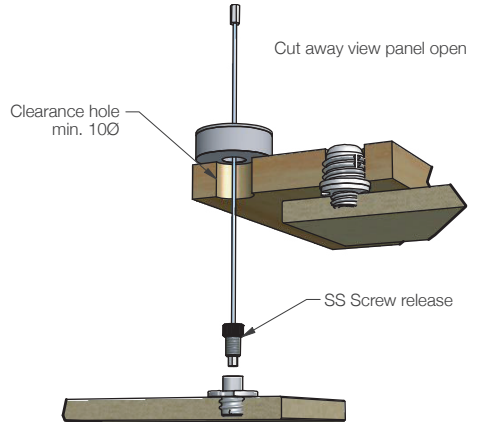
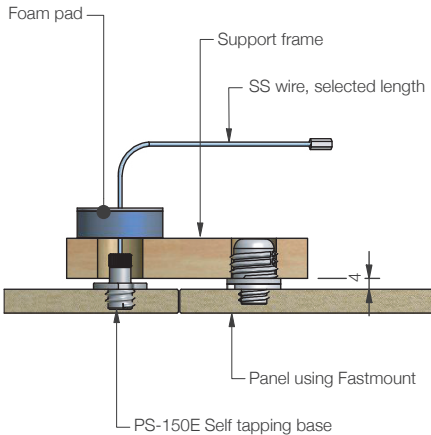

INSTALLATION: Partially exploded through section showing typical installation method



The Fastmount® multi-award winning system has revolutionized the mounting of panels. Panels can easily be removed and refitted in any sequence time after time. For further information or technical support contact: info@fastmount.com

PS-150E + PS-S150E PanelSafe Easy Fit Restraint System

(page 1 of 2)

<div style="display: flex; justify-content: space-around;"> <div style="text-align: center;"> <p>PS-150E</p>  </div> <div style="text-align: center;"> <p>PS-S150E</p>  </div> </div>	<p>USE WITH:</p> <p>PC Standard Range LP Low Profile Range VL Very Low Profile Range MC Metal Range</p>	<p>INSTALL WITH:</p> <p>CP-01ST CT-01 CT-09 CT-07 CT-10</p> 
--	---	---

INSTALLATION STEP OPTIONS Refer to product sheets PS-150E & PS-S150E for more information

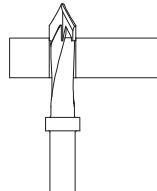
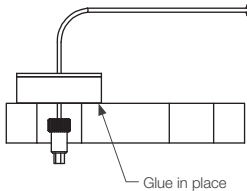
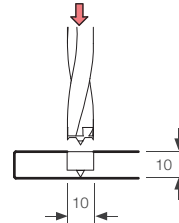
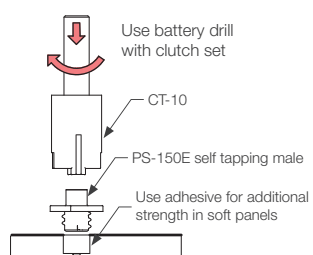
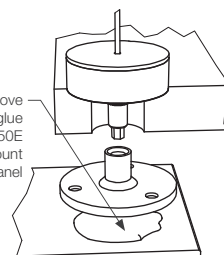
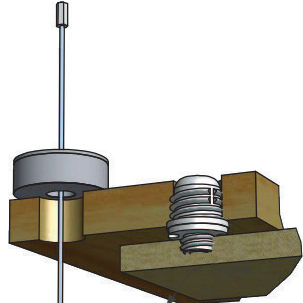
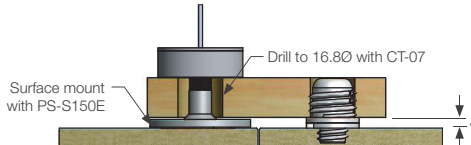
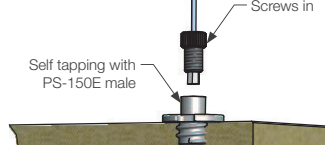
<p>1 Drill hole through support frame</p> 	<p>2 Fit PanelSafe in 10Ø to 16.8Ø hole</p>  <p>Glue in place</p>	<p>3 Self tapping screw in option. Drill panel on center mark 7.5mm deep.</p> 
<p>4 Screw fit PS-M with CT-10</p>  <p>Use battery drill with clutch set</p> <p>CT-10</p> <p>PS-150E self tapping male</p> <p>Use adhesive for additional strength in soft panels</p>	<p>Surface mount option</p>  <p>FM SuperGroove Adhesive to glue PS-S150E surface mount onto panel</p>	
<p>6 Completed installation</p>  <p>Surface mount with PS-S150E</p> <p>Drill to 16.8Ø with CT-07</p> <p>4</p>		 <p>Screws in</p> <p>Self tapping with PS-150E male</p>

PS-150E + PS-S150E PanelSafe Easy Fit Restraint System

(page 2 of 2)

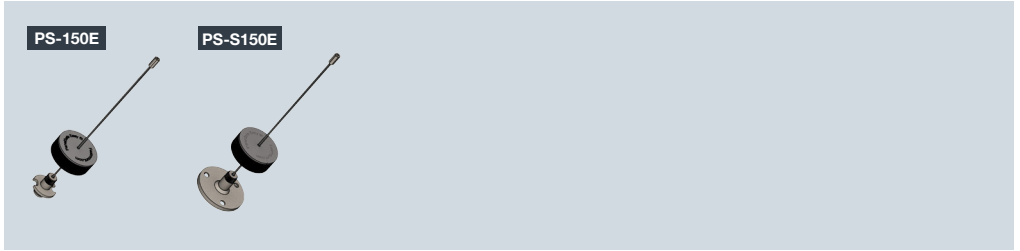

INSTALLATION STEP OPTIONS

- A** Plan view of panel from above with 4 x PanelSafe
 Larger or more flexible panels may require extra PanelSafes for correct support. Each PanelSafe has a static load of 150kgs and a drop load of 10kgs.

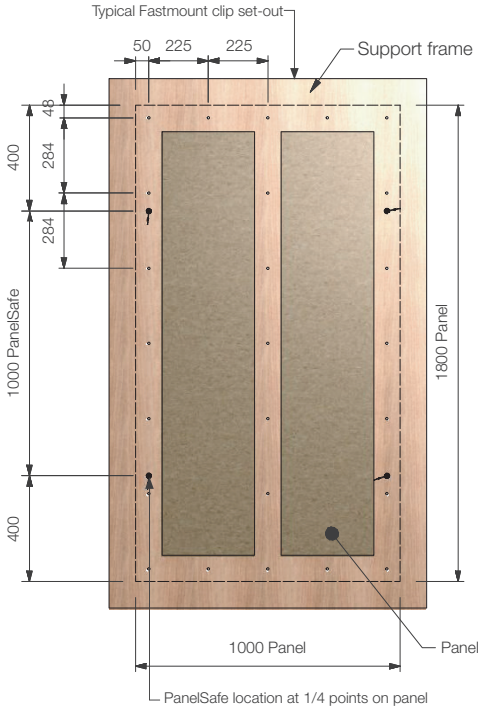

- B** End view with panel down



- C** Plan view of small panel from above with 3 x PanelSafe

